



AL13 architectural
systems

SPECIFICATIONS
COLORS
TECHNICAL DATA

CLEANING & MAINTENANCE
INSTALLATION GUIDE



panel
system

WARRANTY INFORMATION
REQUEST SAMPLES

HEADQUARTERS
1278 CLIVEDEN AVENUE
DELTA, BC.
CANADA V3M 6G4

+1 855 438 2513
+1 604 428 2513
INFO@AL13.COM



No additional off-site fabrication required. Panels are cut to fit on-site and secured using a patented process, saving time and money.

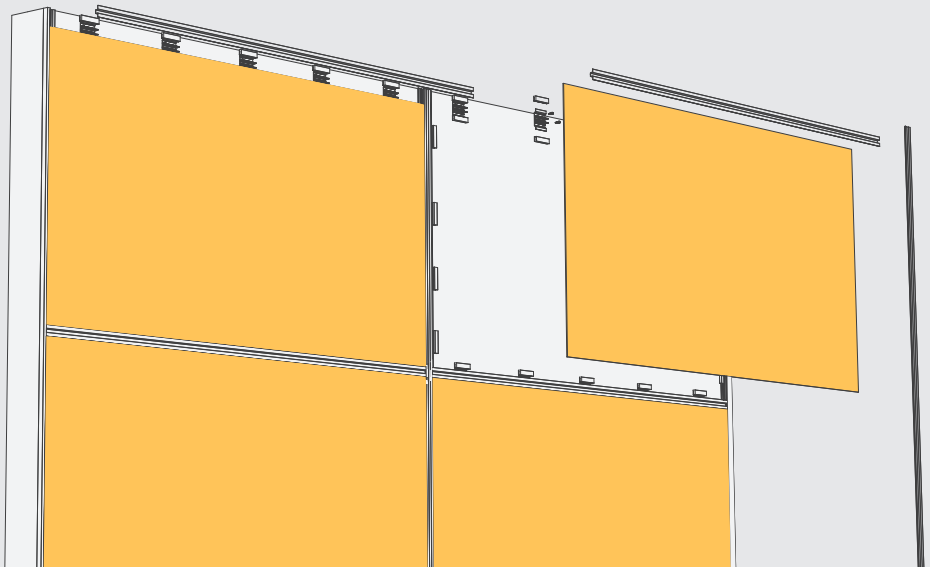

Fire Safety



AL13® Panels are available in standard polyethylene (PE) or fire rated (FR) core.

CAN/ULC-S102

FR Core: flame spread (0) - smoke development (5)

ASTM E84

FR Core: flame spread (0) - smoke development (30)

CAN/ULC-S134 - FR core only

NFPA 285 - FR core only

Wind + Water



AL13® Panels are cut to fit on-site and secured using system frame components, allowing for on-the-fly changes. AL13® system clips and extrusions work together to create a secure system with built-in moisture management.

AAMA 508 - pressure equalized rainscreen

ASTM E330 - windload

Finish



The AL13® Panel System is available in 9 standard solids, 5 wood grains and 4 metallic finishes - custom color matching also available.

AAMA 2605 - coating finish standard

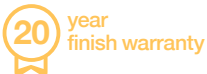

Patented



Years of R&D have allowed AL13® to create an innovative system solution for on-site installation, and alleviate lead time constraints inherent with other products.

most popular solid colors

white
SD323

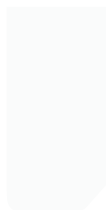

brilliant white
SD301

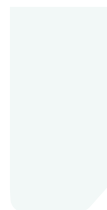

cobblestone
SD302



elephant gray
SD304



battleship gray
SD327



slate
SD330



acorn gray
SD303



galaxy black
SD333



midnight
SD334



most popular metallics

silver metallic
MC309



emery metallic
MC321



pewter metallic
MC322



charcoal metallic
MC308



most popular woodline

beach oak
WD319



harvard maple
WD316



brazilian teak
WD315



swiss pear
WD310



black walnut
WD311



Patented

United States Patent and Trademark Office Canadian Intellectual Property Office

get more info at al13.com/patents

* extrusions are coated in a matching solid tone

PRODUCT DESCRIPTION

PRODUCT FEATURES CANADA

- DESCRIPTION
 - Composite aluminum panels comprised of aluminum skin faced sheets bonded to polyethylene core, or fire-rated mineral fiber core, with high performance fluorocarbon coating finish.
- USES
 - Designed for rainscreen cladding applications.
- PRODUCT ATTRIBUTES AND CHARACTERISTICS
 - Available with polyethylene core or fire-rated mineral fiber, non-combustible core.
 - High performance fluorocarbon finish coating is available in a variety of standard colours including solid colours, wood line finishes. Custom colours are also available.
 - Extruded aluminum panel and perimeter frame assembly and snap-lock top cap for final attachment to frame assembly. Frame components are both two-part snap-locking and one-piece assemblies.
 - Panel dimensions and configurations allow for field adjustment and thermal movement.
- SELECTION CRITERIA
 - Attachment system allows for vertical and horizontal thermal movement due to thermal changes. The product shall not be installed where surface temperatures are anticipated to exceed 82° C (180° F).
 - Unique tab-over design allows for each panel to expand and contract across a broad temperature spectrum without causing buckling or oil-canning.
- SUSTAINABILITY CRITERIA
 - Panels contain recycled content which may contribute to LEED Material and Resources Credit 4 – Recycled Content.
 - Aluminum Skin (of 0.4 and 0.5 mm): 8 percent pre-consumer recycled content (percent in weight)
 - Plastic (of PE Core) 100 percent pre-consumer recycled content (percent in weight)
 - Fire Rated Core: 10 percent of pre-consumer recycled content (percent in weight)

PRODUCT DESCRIPTION

- APPLICABLE CURRENT STANDARDS, RELATED REFERENCES
 - AAMA 508 - Voluntary Test Method and Specification for Pressure Equalized Rain Screen Wall Cladding Systems.
 - AAMA 2605 - Specification for Performance Requirements and Test Procedures for Superior Performing Organic Coatings on Aluminum Extrusions and Panels.
 - ASTM B117 – Standard Practice for Operating Salt Spray (Fog) Apparatus.
 - ASTM B221 - Standard Specification for Aluminum and Aluminum-Alloy Extruded Bars, Rods, Wire, Profiles, and Tubes.
 - ASTM D523 – Standard Test Method for Specular Gloss.
 - ASTM D696 – Standard Test Method for Coefficient of Linear Thermal Expansion of Plastics Between -30°C and 30°C with a Vitreous Silica Dilatometer.
 - ASTM D714 – Standard Test Method for Evaluating Degree of Blistering of Paints.
 - ASTM D903 - Standard Test Method for Peel or Stripping Strength of Adhesive Bonds.
 - ASTM D968 - Standard Test Methods for Abrasion Resistance of Organic Coatings by Falling Abrasive.
 - ASTM D1308 – Standard Test Method for Effect of Household Chemicals on Clear and Pigmented Organic Finishes.
 - ASTM D2244 - Standard Practice for Calculation of Color Tolerances and Color Differences from Instrumentally Measured Color Coordinates.
 - ASTM D2248 – Standard Practice for Detergent Resistance of Organic Finishes.
 - ASTM D2794 - Standard Test Method for Resistance of Organic Coatings to the Effects of Rapid Deformation (Impact).
 - ASTM D3359 – Standard Test Methods for Rating Adhesion by Tape Test.
 - ASTM D3363 - Standard Test Method for Film Hardness by Pencil Test.
 - ASTM D4145 – Standard Test Method for Coating Flexibility of Prepainted Sheet.
 - ASTM D4214 - Standard Test Methods for Evaluating the Degree of Chalking of Exterior Paint Films.
 - ASTM E330/E330M - Standard Test Method for Structural Performance of Exterior Windows, Doors, Skylights and Curtain Walls by Uniform Static Air Pressure Difference
 - ASTM E331 - Standard Test Method for Water Penetration of Exterior Windows, Skylights, Doors, and Curtain Walls by Uniform Static Air Pressure Difference
 - ASTM E1288 – Standard Test Method for the Durability of Biomass Pellets.
 - CAN/CGSB-S102 – Standard Method of Test for Surface Burning Characteristics of Building Materials and Assemblies.
 - CAN/ULC-S134 – Standard Method of Fire Test of Exterior Wall Assemblies.
 - DAF-45 – Aluminum Association Inc. Designation System for Aluminum Finishes.
 - ISO 2360 – Non-conductive Coatings on Non-magnetic Electrically Conductive Basis Materials, Measurement of Coating Thickness, Amplitude Sensitive Eddy Current Method.
 - NFPA 285 - Standard Test Method for Evaluation of Fire Propagation Characteristics of Exterior Non-Load-Bearing Wall Assemblies Containing Combustible Components.

PRODUCT DESCRIPTION

- **PERFORMANCE CRITERIA**
 - General Panel Properties:
 - Thermal Expansion: ASTM D696, 2.4×10^{-5} per degree C
 - Fire Propagation: CAN/ULC-S102
 - Mineral Core Panel to ULC-S102:
Smoke Developed = 5
Flame Spread = 1
 - General System Properties:
 - Wind-Pressure Resistance: ASTM E330: Tested. See Technical Data Sheet (Wind loads)
 - Pressure Cycling: ASTM E1288: Passed 100 cycles.
 - Fire Resistance: CAN/ULC-S134: Passed
- **PACKAGING, HANDLING, PROTECTION, AND DELIVERY INSTRUCTIONS**
 - Deliver materials and related components in manufacturers' unopened containers or bundles, fully identified by name, brand, type and grade. Prevent damage during unloading, storing and installation.
 - Store, protect and handle materials and components to prevent twisting, bending, mechanical damage, contamination and deterioration.
 - Store materials off ground and keep clean, dry, and free of dirt and other foreign matter.
 - Do not expose panels with strippable film to direct sunlight or elevated heat.
- **SPECIAL WARRANTY**
 - Fifteen year limited product warranty against physical defects of systems and products that are properly installed and maintained according to the manufacturer's published application instructions.
 - Finish Coating: Twenty year limited warranty stating finishes shall be free from peeling and checking, chalking of exterior paint, and fading or colour change.
- **LIMITATIONS**
 - Composite aluminum panels must be protected from direct contact with dissimilar metals by a membrane or coating layer.
- **SAFETY PRECAUTIONS**
 - Wear suitable personal protection to avoid cuts.
 - Wear eye protection when cutting, handling and installing panels.

PRODUCT DESCRIPTION

- Panels will be hot when subjected to sunlight.
- AVAILABILITY
 - Available from appointed distributors. See distributor listing on website.
- COST
 - Consult distributors for specific product costs or relative costs.

PRODUCT PROPERTIES

- MATERIALS, COMPOSITION, PROPERTIES
 - Aluminum faces sheets: AA A3003-H24 alloy aluminum sheet with nominal thickness of 0.020 inches (0.5 mm).
 - Back plates, corner frames and end frames: AA 6063-T5 extruded aluminum with wall thickness ~ 0.062 inches (1.57 mm).
 - Panel joint top caps: AA6063-T5 extruded aluminum, two-piece snap together assembly of top cap and backplate, ~ 0.062 inches (1.57 mm) thick.
- ACCESSORIES
 - AL13 adhesive tape for permanent adhesion of I-beam stiffeners to the back side of the ACM panel for added panel rigidity (optional application).
 - Fasteners:
 - Attachment of System frame components to Steel Substrate: #10-16 x 19.05 mm (3/4 inch) self-drilling screws with corrosion-resistant coating. Installed every 60.96 cm (24 inches) on center.
 - Attachment of System frame components to Wood Substrate: #12-14 x 38 mm (1-1/2 inch) mini drill-point fasteners with EPDM composite washers and corrosion-resistant coating. Installed every 40.64 cm (16 inches) on center, unless securing a segmented (8.25 cm) (3 1/4 inch) backplate (installed 40.64 cm (16 inches) on center), in which case two fasteners per segmented piece are required.
 - Attachment of System frame components to Concrete walls: 6.35 mm (1/4 inch) diameter threaded stainless steel concrete screw anchor. Minimum embedment into concrete of 31.75 mm (1 1/4 inch). Ultimate withdrawal resistance shall be a minimum of 750 lbf. Installed every 60.93 cm (24 inches) on center.
 - Note: For larger installed areas over concrete, it is recommended to install a furring bar or Z-girt for panel attachment. Attaching frame components directly to concrete is time consuming.

PRODUCT DESCRIPTION

- Fastener Corrosion Resistance:
 - Carbon Steel: Coated to provide not less than 1,700 hours of ASTM B 117 salt spray performance with no white or red rust; 18 cycles of ASTM G 87 (DIN 50018) SO² Kesternich testing with not more than 15 percent red rust.
 - Stainless Steel: 304, 305 or 316 Series Stainless Steel.
- SHAPE, MASS, AND DIMENSION
 - Panel Weight:
 - Polyethylene core:
 - 3 mm/0.50 mm (0.12 inch/0.02 inch): 4.71 kg/m² (0.96 lb/ft²)
 - 4 mm/0.50 mm (0.16 inch/0.02 inch): 5.71 kg/m² (1.17 lb/ft²)
 - Fire-rated mineral fiber core:
 - 3 mm/0.40 mm (0.12 inch/0.12 inch): 6.20 kg/m² (1.27 lb/ft²)
 - 4 mm/0.50 mm (0.16 inch/0.02 inch): 8.18 kg/m² (1.68 lb/ft²)
 - Overall panel thickness: 3 mm (0.12 inch) or 4 mm (0.157 inch).
 - Standard panel size of 1220 mm x 2440 mm (4 foot x 8 foot).
 - Custom sizes available, up to a maximum of 1524 mm x 3048 mm (5 foot x 10 foot).
- FINISH, COLOURS AND TEXTURES
 - High performance finish coating in compliance with AAMA 2605.

PRODUCT INSTALLATION

- PREPARATION
 - Ensure structural supports are aligned and meets structural requirements for wind loading and gravity loads.
 - Ensure building surfaces are smooth, clean, dry and free from defects detrimental to installation of cladding system.
 - Ensure framing is planar with variations on not more than ¼-inch in ten feet.
 - Inspect cladding and components before installation and verify that there is no shipping, storage, or staging damage. Do not install damaged cladding. Remove from jobsite to avoid re-application.
 - Ensure all products received are as ordered/required for project, including finish and size.

PRODUCT DESCRIPTION

- **INSTALLATION**
 - Install products in accordance with manufacturer's published handling and installation instructions.
 - Erect components plumb and true.
 - Adjust assembly to secure cladding safely to wall while allowing for calculated expansion and contraction of components. Ensure extrusion tabs overlap cladding edges by at least half of extrusion tab depth.
 - Do not cut, trim, weld, or braze component parts during erection in manner which would damage finish, decrease strength, or result in visual imperfection or failure in performance.
 - Apply isolation coating to areas of contact between dissimilar metals.

Corporate Identification

AL13® Architectural Systems

Toll Free Number + 855.438.2513

General E-mail info@al13.com

Order Support orders@al13.com

Website <http://www.AL13.com/>

Technical Services Available

Phone or e-mail for technical services. Check website for technical support.

Classification and Filing

MasterFormat 2018:

07 42 43 – Composite Wall Panels

01

✔ Cleaning & Maintenance

Dirt and other deposits may naturally accumulate due to specific environmental conditions. These build ups and deposits take away from the original aesthetic properties. AL13 recommends implementing a regular cleaning program to maintain the best possible appearance.

General cleaning:

- Surfaces may be cleaned with water using a soft brush or sponge free of debris. Avoid excessive rubbing.
- If necessary, surfaces may be cleaned with a mild detergent (pH 6-7) or cleaning agent diluted 1:50 parts water.
 - Some cleaning products may damage the finish. Using highly acidic or alkaline cleaning agents may corrode the aluminium and paint. If unsure, complete a small test area in an inconspicuous location before proceeding. If the solution results in any irregularities to the finish, discontinue use immediately. Always use all recommended safety precautions including appropriate skin and eye protection to prevent irritations or burns.
- After cleaning occurs, surfaces should be rinsed with clean water to remove any residue that might be present.
- To reduce the appearance of water spots or streaking, surfaces should be squeegeed or wiped dry with a clean cloth before the water is allowed to do so naturally. Surfaces heated by the sun will dry more quickly.

02

✘ Do Not

- Do not clean AL13 using steel wool or abrasive pads.
- Do not clean AL13 with Acetone, paint thinners or removers.
- Do not clean AL13 with highly acidic or alkaline solutions.
- Do not clean AL13 with a pressure washer.



AL13[®] Panel System Installation Guide



Patented



United States Patent
and Trademark Office



Canadian Intellectual
Property Office

get more info at al13.com/patents

01

Installation Guidelines 1

IMPORTANT: Failure to follow the guidelines herein will void the AL13® warranty

Please read and understand this guide. Any questions or inconsistencies should be directed to info@al13.ca

Guidelines may vary depending on project particulars and conditions. Contact AL13® with questions regarding variance from this guide. Standard carpentry skills are required for optimum results. Good health and safety practices must be followed when installing AL13® ACM System. Please refer to the AL13® Material Safety Data Sheets for more info.

Key steps for a successful installation

- 01 Understand the various elements of the system
 - 02 Plan the installation, work schedule, layout, and material usage
 - 03 Ensure everyone working has read the installation guidelines
 - 04 Execute work in the sequence set forth in the installation guidelines
 - 05 Protection should be worn; gloves, ear protection, steel toe boots, safety glasses and hard hat
 - 06 Protect the product by storing the material in a dry and clean environment
 - 07 Ensure proper fit of the system
 - 08 Upon completion of installation remove protective film and clean any debris on wall
-

Pre-installation: Receiving materials



When materials arrive on site, ensure that all panels, extrusions and other component packaging are in good condition, free of any defects, and verify that the materials match the order / shop drawings.

- > Shipping or packaging issues should be noted on the waybill and then reported to the distributor.
- > Should any products be damaged, the receiving party is responsible for filing a freight claim to the shipping company within 24 hours of receiving product.
- > Defective materials should be reported to the distributor from which the product was dispatched from.

01







Installation Guidelines 2

Product Legend: This installation guide will discuss various components of the system and use component reference blocks. Please refer to the following to verify the correct component.

Component	Size / piece	Material
 3mm ACM Panel	4' x 8' sheet	AAMA 2605 coated with PE core or FR core
 4mm ACM Panel	4' x 8' sheet	AAMA 2605 coated with PE core or FR core
 End Frame	8' length	AAMA 2605 coated aluminum extrusion
 Inside Corner	8' length	AAMA 2605 coated aluminum extrusion
 Outside Corner	8' length	AAMA 2605 coated aluminum extrusion
 Half Back Plate	8' length	Anodized aluminum extrusion
 Full Back Plate	8' length	Anodized aluminum extrusion
 Reveal Cap	8' length	AAMA 2605 coated aluminum extrusion
 Perimeter Reveal Cap	8' length	AAMA 2605 coated aluminum extrusion
 Flat Cap	8' length	AAMA 2605 coated aluminum extrusion

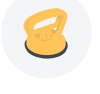

01

Installation Guidelines 3

Component	Size / piece	Material
 Perimeter Flat Cap	8' length	AAMA 2605 coated with PE core or FR core
 I-Beam	8' length	Aluminum Extrusion
 4mm Panel System Clip	box (100)	Fiberglass reinforced plastic
 3mm Panel System Clip	box (100)	Fiberglass reinforced plastic
 Wood Fastener	500/package 1-1/2" long	Wood Substrate: #12 - 14 x 1 1/2" mini drill-point fasteners with EPDM washers and corrosion-resistant coating
 Concrete Fastener	100/package 1-1/4" long	Concrete Walls: #11 x 1 1/4" concrete screw anchor with corrosion-resistant coating.
 Metal Fastener	500/package 3/4" long	Steel Substrate: #10-16 x 3/4" self-drilling, self-tapping screws with corrosion-resistant coating
 Suction Cup	each	coated aluminum

01

Installation Guidelines 4

Component	Size / piece	Material
 80T Non ferrous Saw Blade	10 " - each	carbide tip / high-speed steel
 60T Non ferrous Saw Blade	6-1/4" - each	carbide tip / high-speed steel
 AL13® Gloves	each	rubber / lycra
 Flat SLED	each	plastic and rubber
 Reveal SLED	each	plastic and rubber
 AL13® Tape	108' roll	AL13® double sided acrylic adhesive tape

01

Installation Guidelines 5

Inventory

Once material is verified to be in good condition, take inventory of units according to the packing slip. Make sure all materials - panel, extrusion, fasteners, and adhesive tape - and quantities are present.

The distributor should be notified immediately if the order has any missing or incomplete components. Failure to do so may void re-fulfillment.

Material handling

AL13[®] ACM System panels are shipped on pallets in 50 sheets (or less). The sheets are secured in place with metal strapping and covered with protective wrap. Panels should be kept in their original packaging or similar and moved by a forklift or pallet jack.

Once a pallet is unwrapped and metal straps are cut, panels may be moved individually. Ensure to use clean work gloves to protect from sharp edges and keep panels clean. Panels must be first lifted vertically away from panel, then away DO NOT DRAG OR SLIDE panels.

Store all materials in a clean and dry environment, both before and after materials are unpacked.

Wear gloves when handling materials, and use suction cups when mounting panels to wall. Ensure to wear eye and ear protection when cutting materials. Always wear appropriate personal protective equipment.

Tools

Our Panel System is made to be installed with general tools, a recommended tool list is as follows:

- > Sawhorses/work table
- > Circular saw, handheld with guide
- > Table saw
- > Cordless electric impact with appropriate bits
- > AL13[®] saw blades
- > AL13[®] SLED tool
- > AL13[®] suction cups
- > Jigsaw
- > File (for de-burring cut sheets)
- > Level/plumb line
- > Chalk line
- > Cordless electric drill
- > Drill bit set

01

Installation Guidelines 6

Panel layout

It is important to commence work with good construction practice and schedule work with other trades to avoid delays. Once installation begins it must not be delayed for any length of time as damage may occur to the system, substrate or both due to exposure to the elements. Before any installation begins, it is imperative to plan the layout of the system. The architectural plans/elevations should be reviewed to determine the appropriate 'grid' for the system. Should no such plans be available, measure areas to develop a pattern that will maximize panel size, aesthetics and minimize fabrication.

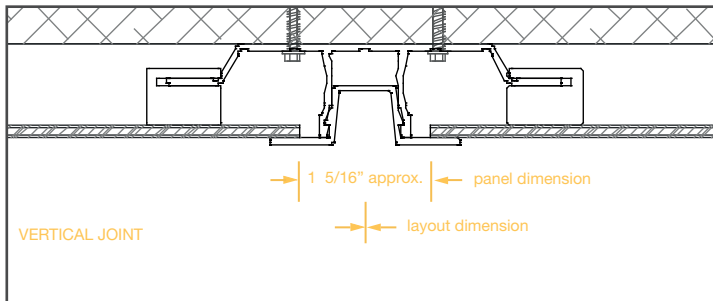

Standard panel size is 4' x 8' (1220mm x 2440mm). Do not use these dimensions for determining layout lines, adequate space must be left between panels for extrusions.

Material use

Once the layout has been determined, double check that there is an adequate amount of materials present for the application at hand. Since estimation takeoffs and quantities are based on panel layout, any installation varying from the original plan may affect quantities and cause material shortages. Make sure to check the cut plan to determine if this will result in any further shortages. When calculating material usage, note that vertical extrusions - in most cases - will carry through continuously, while the horizontals tuck and terminate under the tabs of the verticals.

AL13[®] Panel System.

AL13
Architectural
Systems

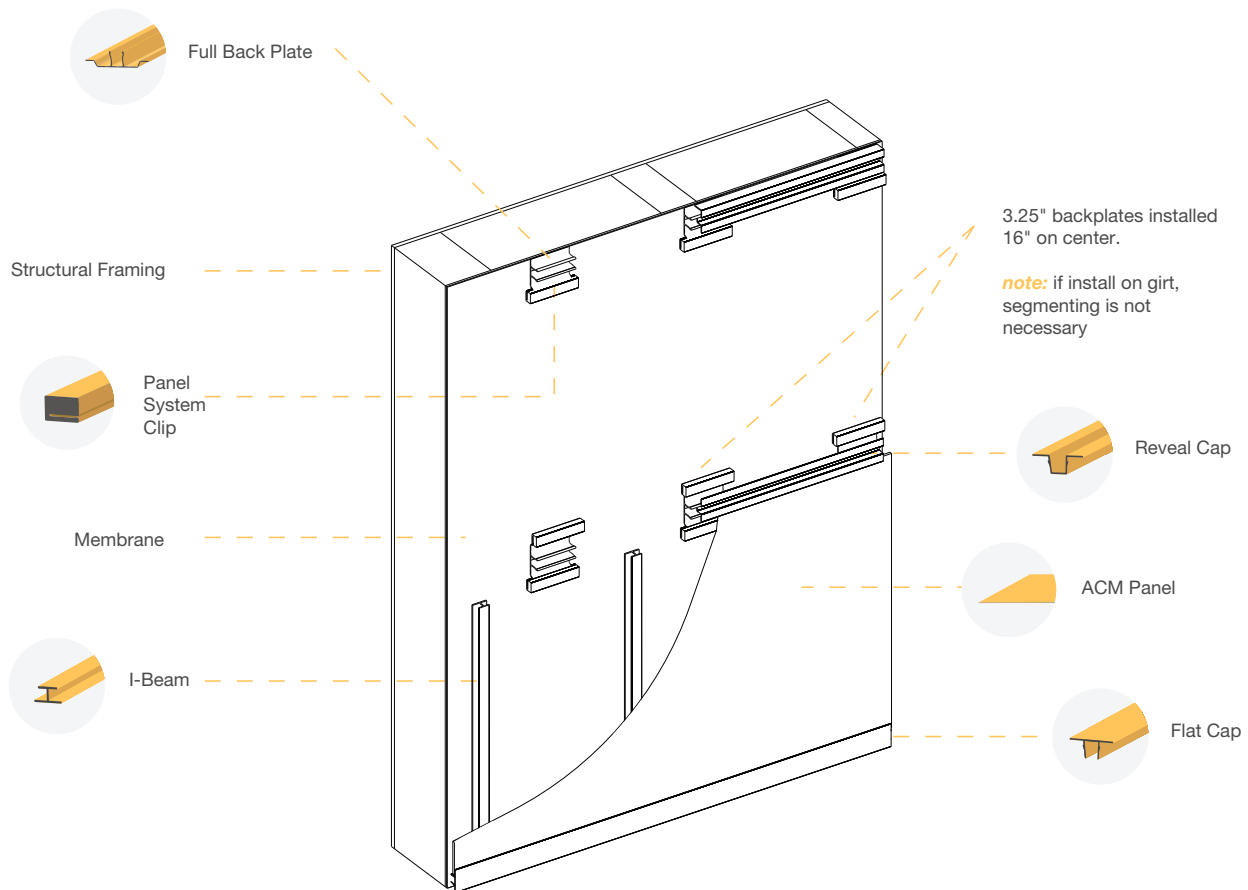

The backplates and various caps use an interference fit and require an impact to engage the two components. Ensure that the substrate is solid enough to sustain this impact.

02

Panel Install 01

Example wall

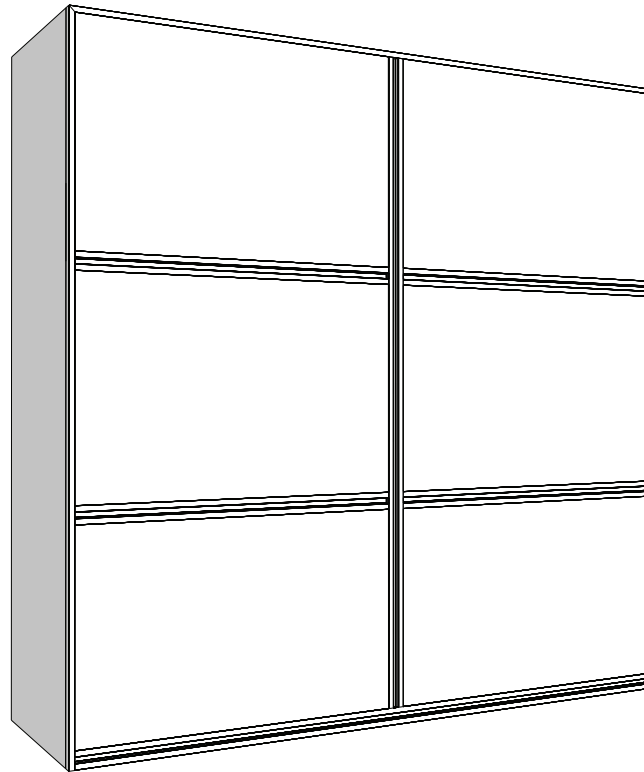

The first part of the installation guide outlines a basic install on a flat wall as illustrated above in its completed form. The subsequent sections will outline more intricate details like inside corners, outside corners, windows, doors, overhangs and build-outs. (Please be sure to have read the General Install section first).

The building envelope, which includes weather barrier and all applicable flashings, must be completed to local building code before any AL13® component is to be laid-out or installed.

02

Panel Install 02

Laying out the grid

IMPORTANT!

Successful install relies on a properly built and prepared substrate - substrate flatness is especially critical.

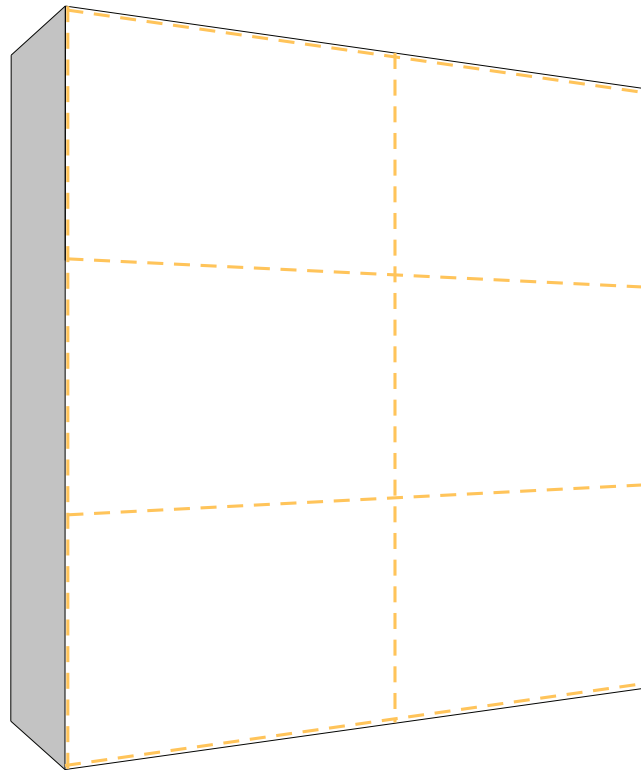

Using the chosen layout, determine the best suited datum - or starting point - shown here as the lower left corner. Lay out the panel grid using chalk lines (or similar) from the datum point, ensuring that all lines are plumb and level. These lines are to indicate the locations of the extruded frame components that will secure and frame the ACM panel.

02

Panel Install 03

Fasten vertical perimeter extrusions

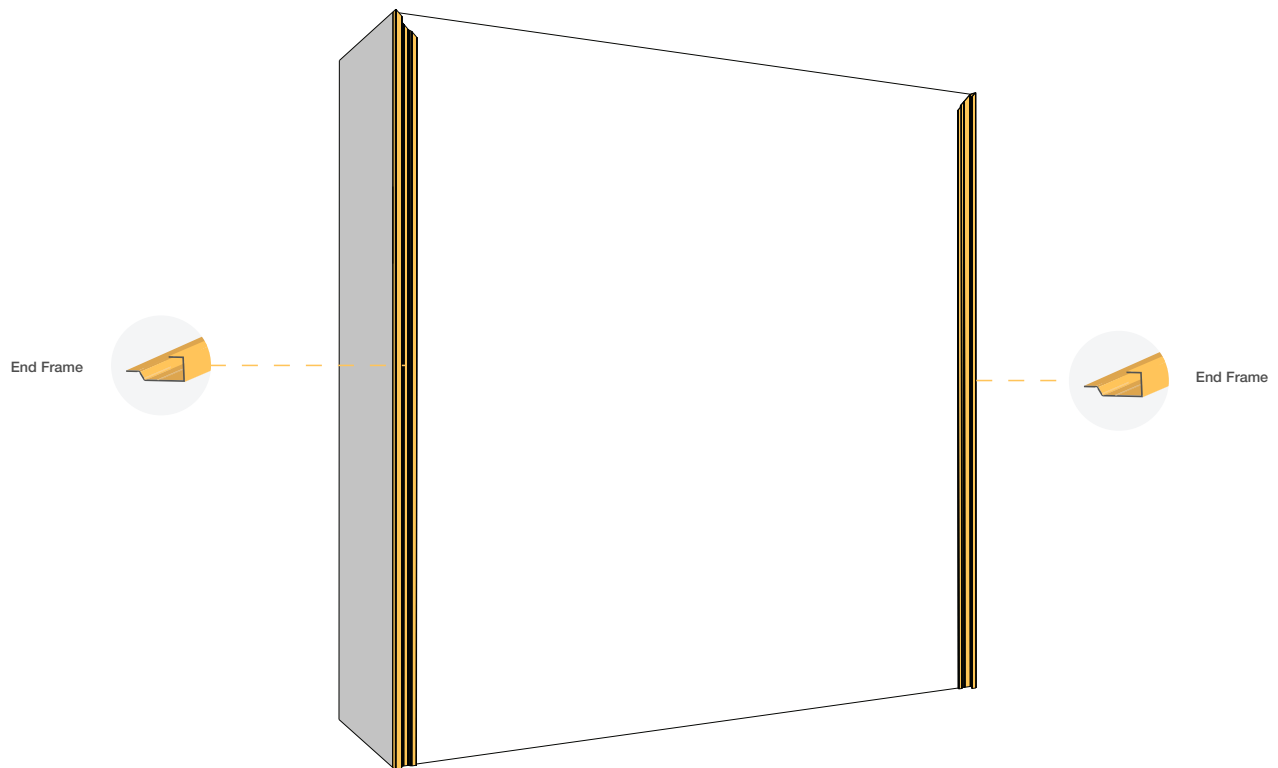

Measure and cut the vertical End Frames according to the marked grid lines. If the top of the vertical End Frame is to meet another horizontal End Frame at 90 degrees, a 45-degree mitre cut is to be made on both parts to complete the angle. This will eliminate the need to notch extrusions. If the wall is to be finished with a half back plate and perimeter cap, the 45-degree mitre is not necessary, as the horizontal cap will tuck behind the vertical end frames.

It is the preferred method to fasten the top part of the extrusion first (upper 3"), then the bottom (lower 3"), followed by all fasteners in between. Typical Fastener spacing on all extrusions with the 4mm ACM Panel system is to be no greater than 24" with a minimum of 2 fasteners per extrusion. Fastener spacing may be decreased, to add additional pull out capacity. Consult the product specifications to determine fastener type and spacing.

**An Outside Corner Frame, Inside Corner Frame, or a Perimeter Frame Assembly may be used in place of the End Frame in this situation. The End Frame is shown here only to keep the scope of this guide relatively simple.*

02

Panel Install 04

Fasten top horizontal extrusion

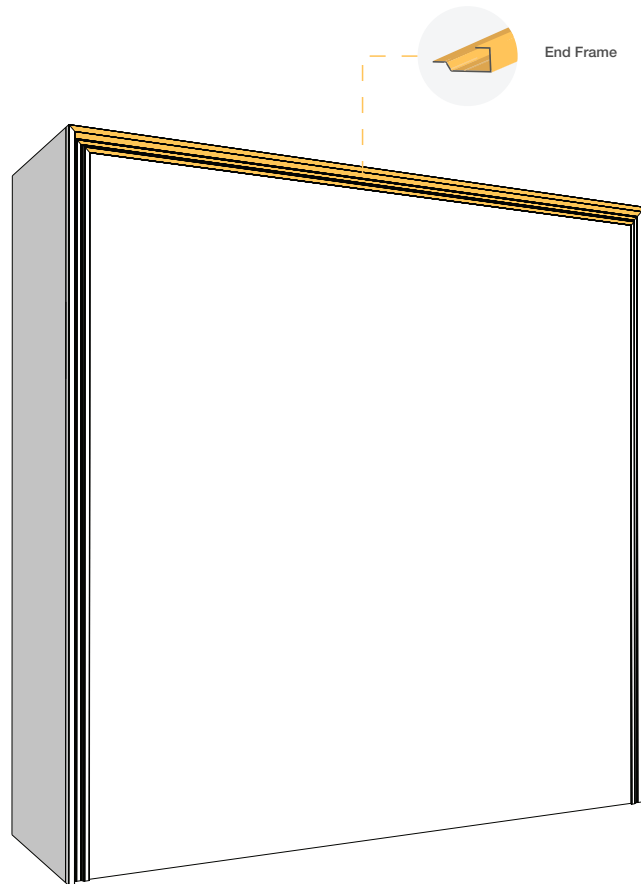

The upper End Frame is next to be measured and cut-to-size. A double mitre could be required if the vertical End Frames are mitered at 45-degrees (as outlined in the previous step).

If one length of the End Frame extrusion is not long enough to span the distance required, it is necessary to use a second piece and butt the two together. Take care in aligning joints so that they are flush, shim as needed.

02

Panel Install 05

Fasten baseline extrusion backplates

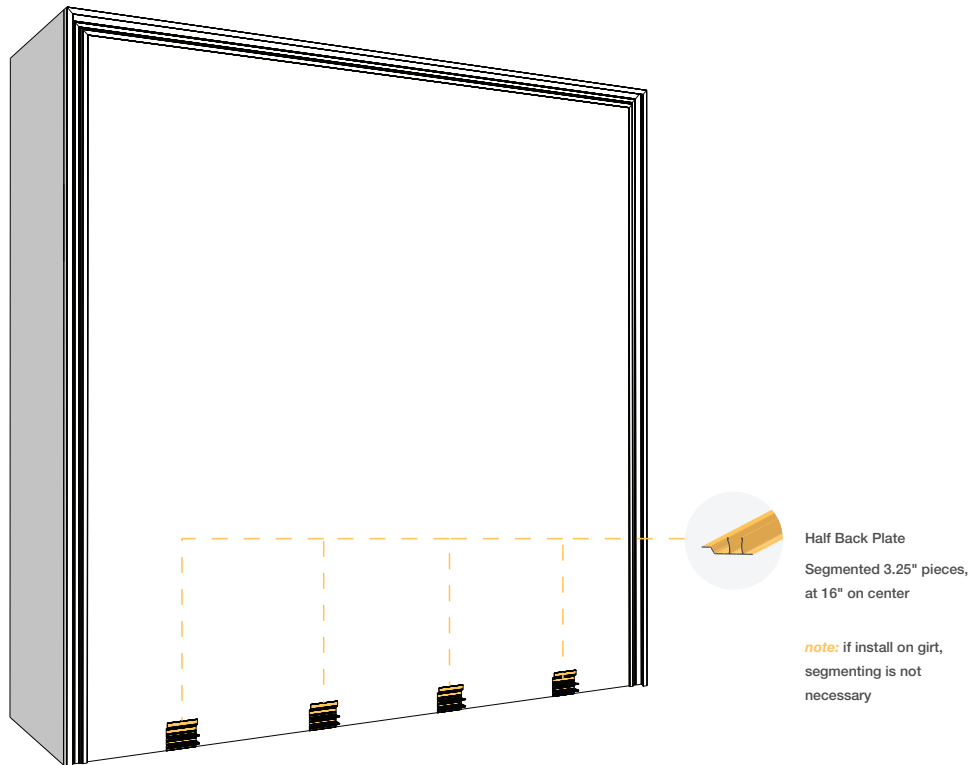

AL13's Panel System is a rain screen system that does not require any strapping.

The bottom row is comprised of segmented half back plate sections, cut to a length of 3.2" and installed every 16". This ensures that, at any given horizontal cutaway, only 20% of the material is attached to the wall to an 80% open cavity. This provides necessary capillary break and fulfills the rainscreen requirements.

02

Panel Install 06

Fasten baseline extrusion

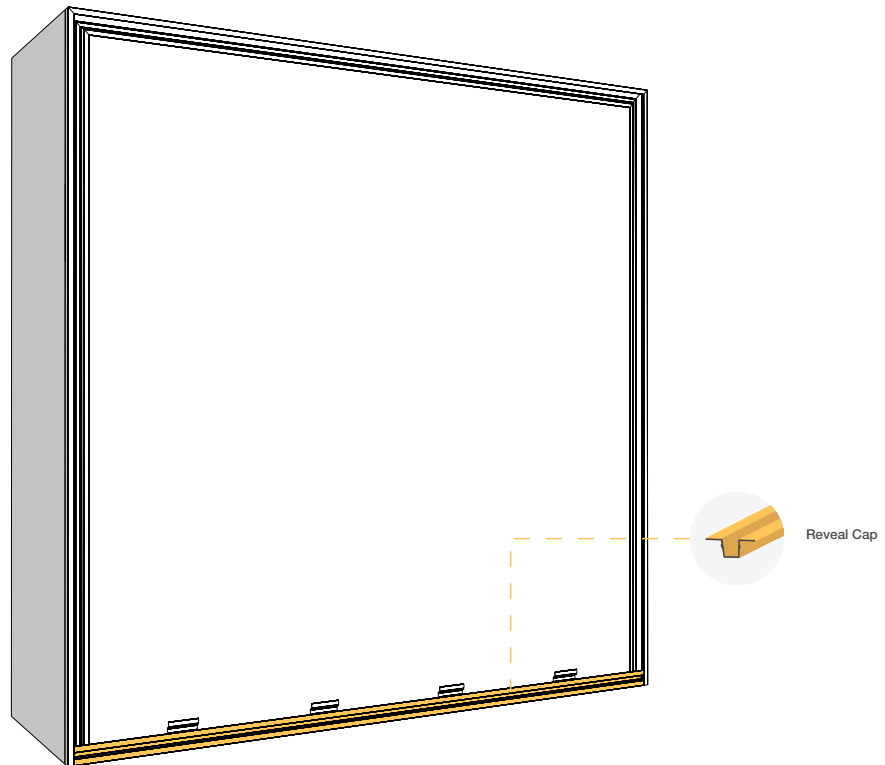

Measure and cut the bottom horizontal top cap. A proper fit will ensure that either end may be tucked into the vertical endframes, leaving a minimum 1/8" gap to allow for proper contraction and expansion of the extrusion.

Engage the top cap into the segmented back plates using an AL13® SLED with a rubber mallet. It is imperative to only make contact where back plates are present so as not to damage or warp the top cap.

02

Panel Install 07

Fasten vertical back plate

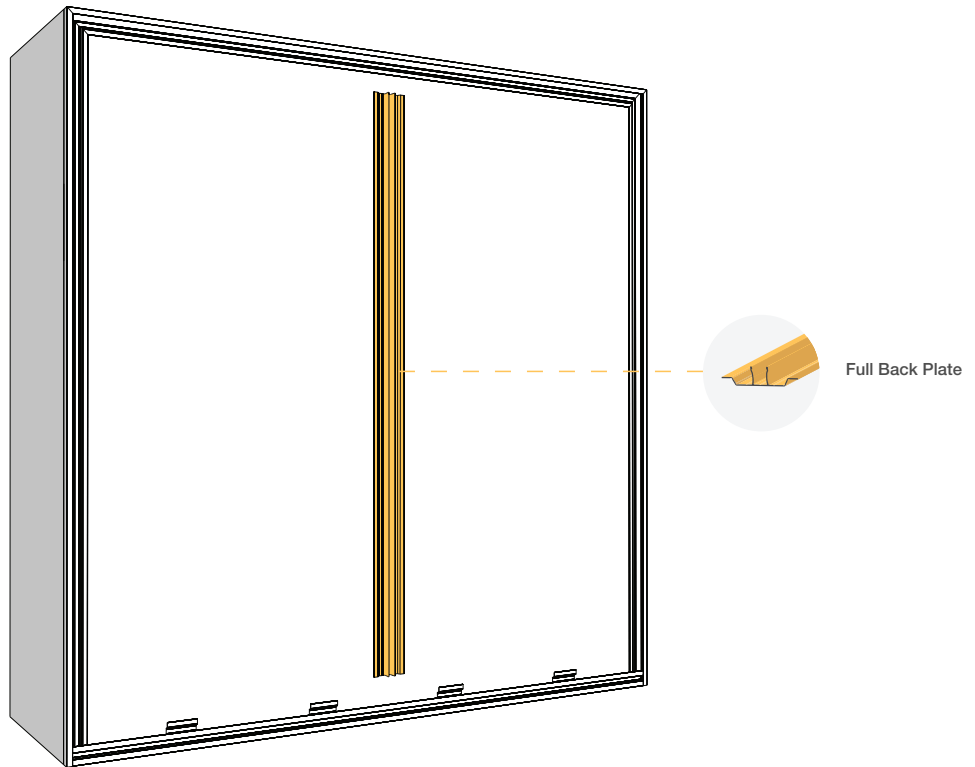

Measure and cut the vertical full back plate. Allow for approximately 2" gap from horizontal upper and lower extrusions to allow for proper top cap installation. Begin by fastening the top of the extrusion first (upper 3"), followed by the bottom (lower 3"), then the intermediate fasteners.

02

Panel Install 08

Fasten horizontal full back plate segments



Measure and cut horizontal back plates in 3.25" segments and install them every 16" as per the layout. If you are fastening to a minimum of ½" ply or OSB sheathing, it is not necessary to fasten segments to a stud. It is recommended to pre-drill the holes in the segmented back plate pieces. This will prevent the small pieces from spinning while fastening - which aids in eliminating the possibility of a cut hazard.

It is important to install the segments ensuring they are completely plumb and straight. A Level or straight edge may be used to assist with alignment.

02

Panel Install 09

Attach system clips

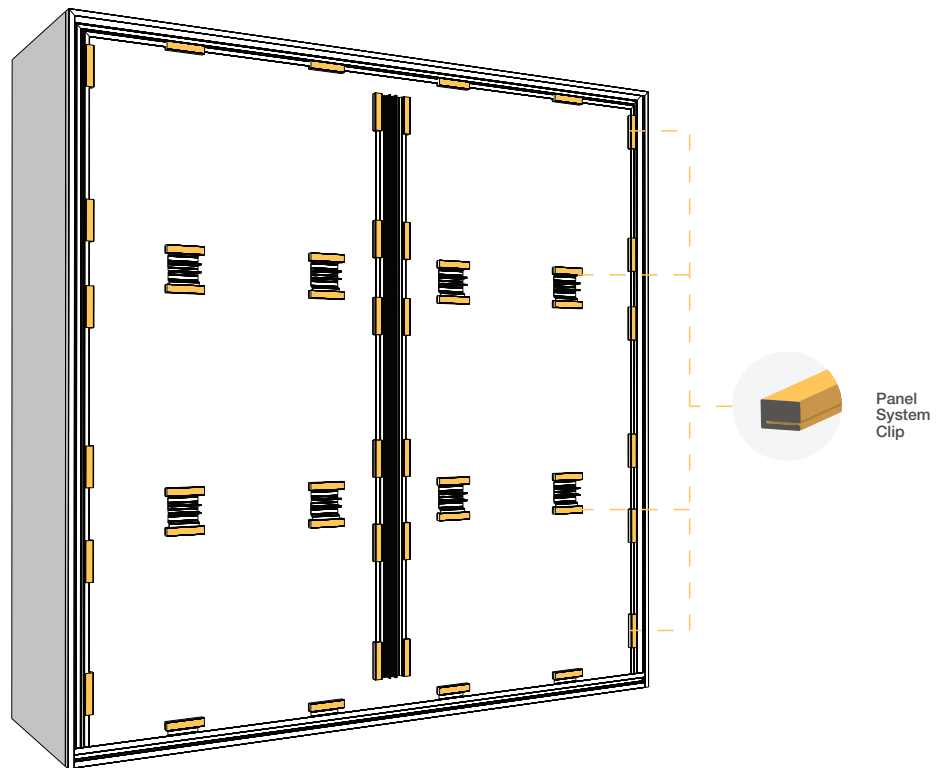

Once all extrusions have been installed it is time to attach system clips to all the extruded frame components. System clips act as spacers and are installed with the thin tab pointing towards the wall and the thicker portion facing away from the wall. System clips keep the panels tight to the frame without the need for adjustment.

System clips are to be attached at a minimum every 16", or 1 system clip per tab on the smaller segmented horizontal pieces. Position system clips 6-8" away from corners and intersections.

System clips are intended to be a firm and secure friction fit. Repeated attempts pulling the clip off and snapping it back on may weaken the integrity of a clip. Once a clip has been snapped in place, it should not be repeatedly taken off and snapped back on. If any clip is found to have been weakened through repetitive use, it should be discarded and a new one used in its place to ensure a secure fit.

02

Panel Install 10

I-beam installation (optional)

Standard 4' x 8' sheet

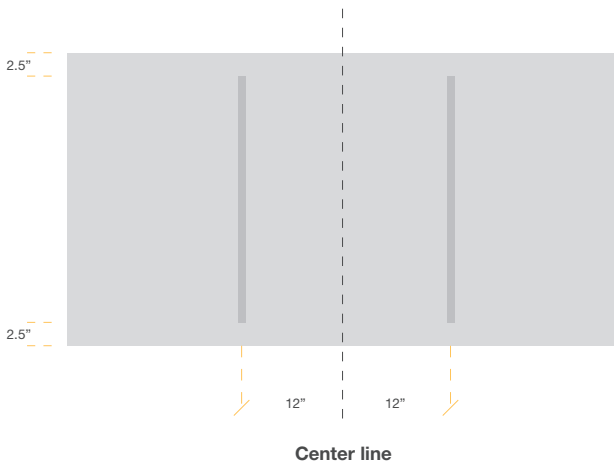

Cut sheet

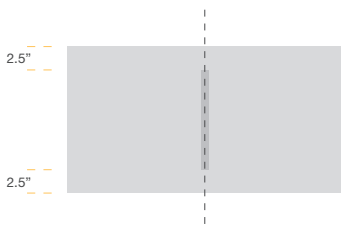

I-beams may be used in conjunction with the panels to provide additional panel rigidity.

Step 1 - Cut I-beams to fit. Appropriate sizing should be offset from either edge of the panel 2 1/2". Full 4'x8' panels will require 2 I-beams set back 12" from center. Panels 6' or below only require 1 I-beam, running in the narrow direction, at the center of the panel.

Step 2 - Ensure both of the surfaces are free of dirt, debris or contaminants to ensure full adhesion. For best performance it is suggested to clean both surfaces using Isopropyl Alcohol, which is free of solvents and will not damage any finished surfaces.

Step 3 - Apply double sided adhesive the full length of the narrow leg of the I-beam. Remove the protective backing and carefully attach to the cleaned back side of the panel. Once set in position, apply pressure along the length of the I-beam to ensure even full contact with the back side of the panel.

02

Panel Install 11

ACM panel fit

IMPORTANT!

It's critical AL13® Panels are not cut too small relative to their frame components. Only a max 1/8 inch gap is allowed around the perimeter of the Panel.

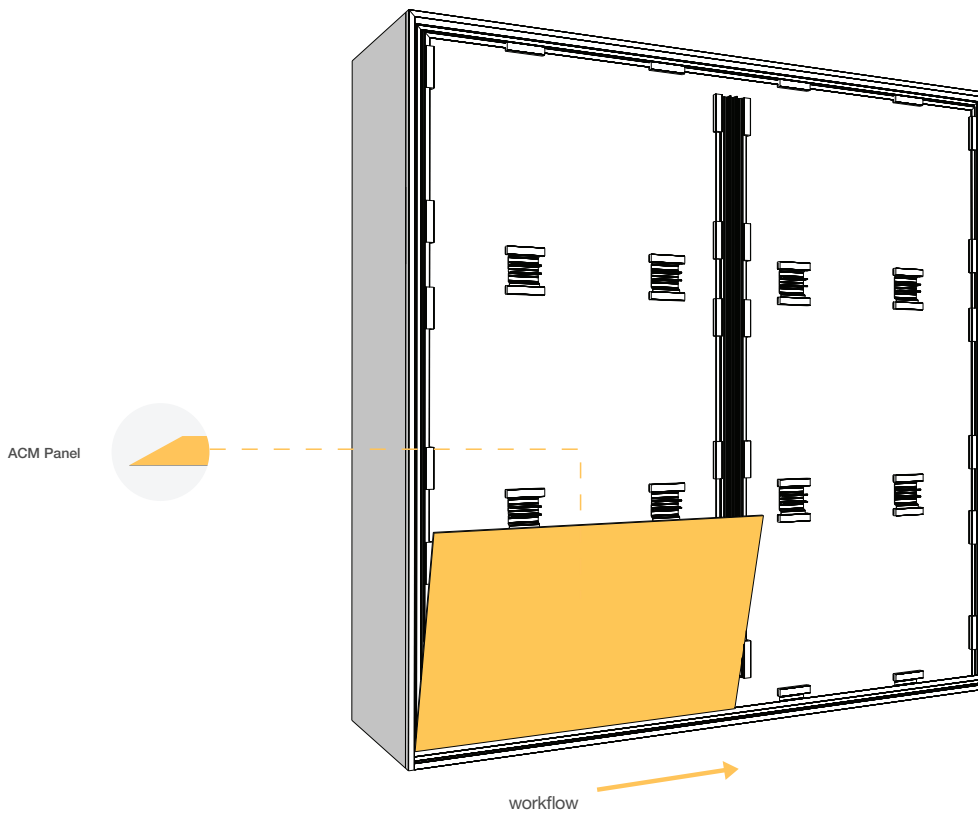

The ACM Panel may need to be cut down if a smaller size from the standard 4' x 8' (1220 x 2440 mm) is required. This may be done on a standard circular saw, panel saw or table saw - so long as an AL13® blade is used. Use a guide to ensure cuts are straight and clean. The appropriate panel fit should account for approximately a 1/8" gap on all sides to allow for expansion and contraction of the metal.

Once a panel is ready to be fit, it may be taken off the stack. Make sure not to drag sheets across, rather lift the sheet up off the stack, then away. Although the panels have a protective film applied from the factory, reckless panel handling may cause damage to panel through the wrap. It is recommended that at least two persons carry one sheet. The protective film should be peeled back approximately 1" (25 mm) from the edges, but should remain on the panel otherwise. Gloves should be worn to keep panel clean and to protect hands from sharp edges.

** Suction cups are recommended for installing panels as they allow for much greater grip and free your hands from a potential pinch hazard.*

Step 1 - position panel on its long edge, lift it up and place in position.

Step 2 - shift the panel towards the wall.

Step 3 - Once the panel is flush, slide it under the tab of the vertical End Frame.

02

Panel Install 12

Install reveal cap and lock into place with AL13[®] sled

IMPORTANT!
Make sure Top Caps are fully engaged. Hammer the AL13[®] SLED firmly to engage with Back Plate. When backplate is segmented only hammer on top on the Back Plate segments.

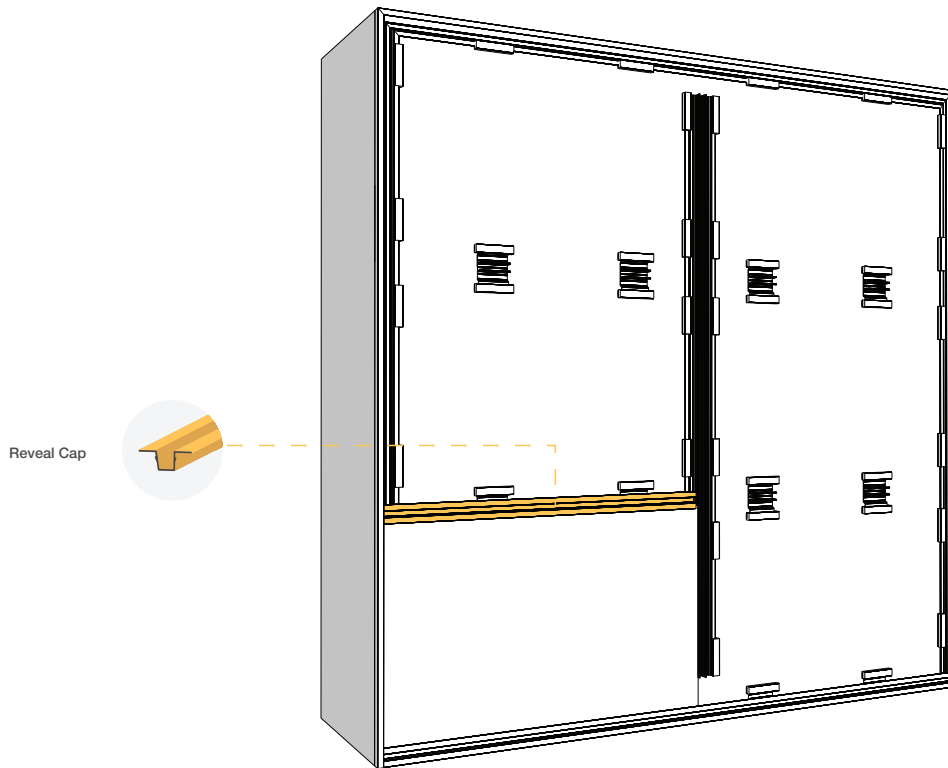

After the ACM Panel has been shifted into the correct position you must securely fasten it in place with a top cap. The top cap is the second part of the two-part Panel Frame Assembly which is snapped into place with a rubber mallet and the AL13[®] SLED.

Once the top cap is cut to the appropriate length, it may be engaged with a rubber mallet and the AL13[®] SLED. Where a horizontal top cap intersects a vertical End Frame, it should slide under the tab of the End Frame. Be cautious to only impact the top cap where a back plate is present to prevent any deformation of the frame components. The horizontal top cap should sit halfway under the tabs of the vertical frame components, in the same manner as the panel. Therefore, the horizontal top cap may be cut and positioned to match the panel.

02

Panel Install 13

Repeat previous two steps for the next panel

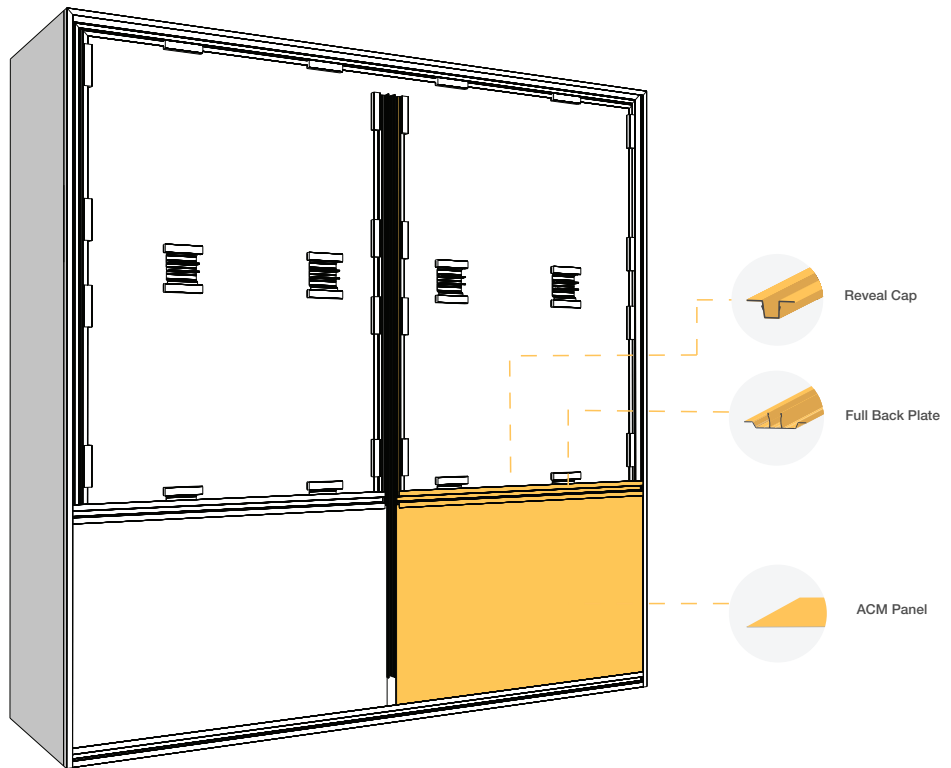

Continue workflow to the right and repeat previous steps for remaining panels on the first row of the wall.

02

Panel Install 14

install top two panels

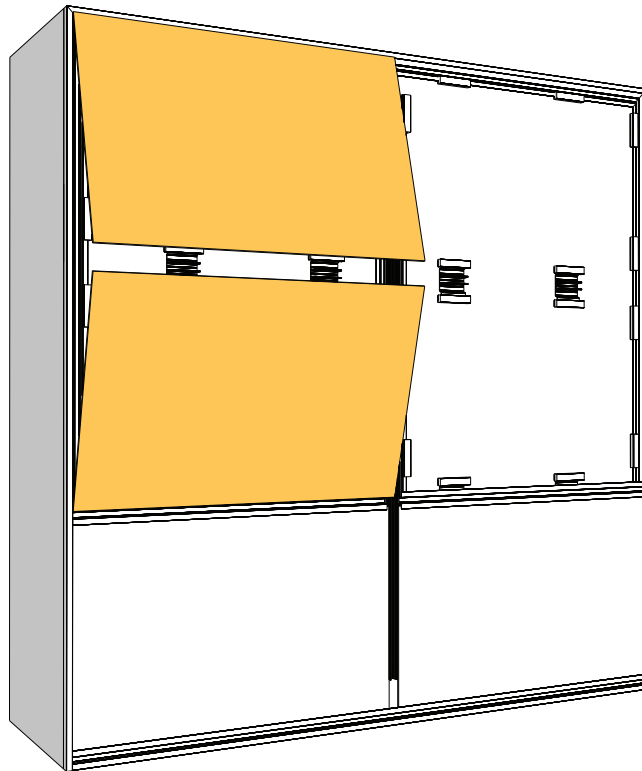

The top two panels in a column must be installed simultaneously. Since the top of the wall terminates under the horizontal End Frame, it would be impossible to place the upper panel if the below top cap was already secured.

Step 1 - Install lower panel and hold in place while second panel is fitted.

Step 2 - Slide upper panel upwards under the tab of the horizontal End Frame.

Step 3 - Slide the panel underneath the vertical End Frame.

Panel Install 15

Lock top panels into place with the top cap

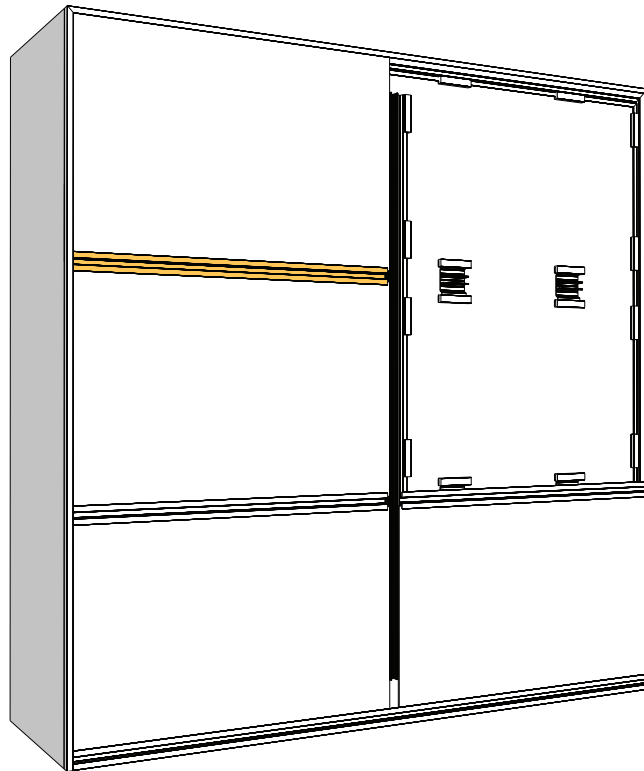

After the ACM Panels have been shifted into the correct position, the horizontal top cap will secure the panels in place. Once the top cap is cut to the appropriate length, it should be placed, one end first, into place, with each end under the tabs of the horizontal End Frames. Once in the correct position it is to be hammered into place with a rubber mallet and AL13[®] SLED.

02

Panel Install 16

Repeat for the other side and lock into place

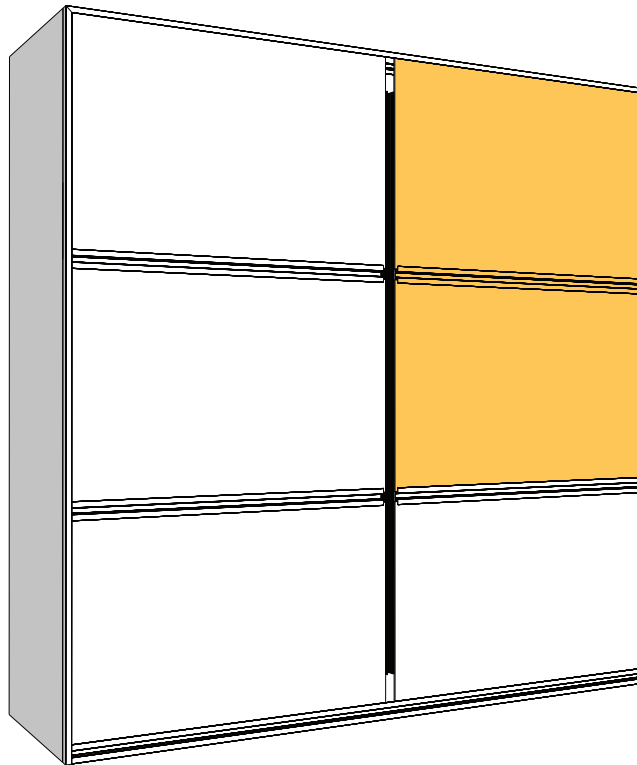

Continue workflow to the right and repeat previous steps for remaining panels on the top row.

02

Panel Install 17

Install vertical top cap and lock into place

IMPORTANT!

It is critical when two Top Caps meet the joint should take place on the same Back Plate, and at least 6 inches away from any intersection.

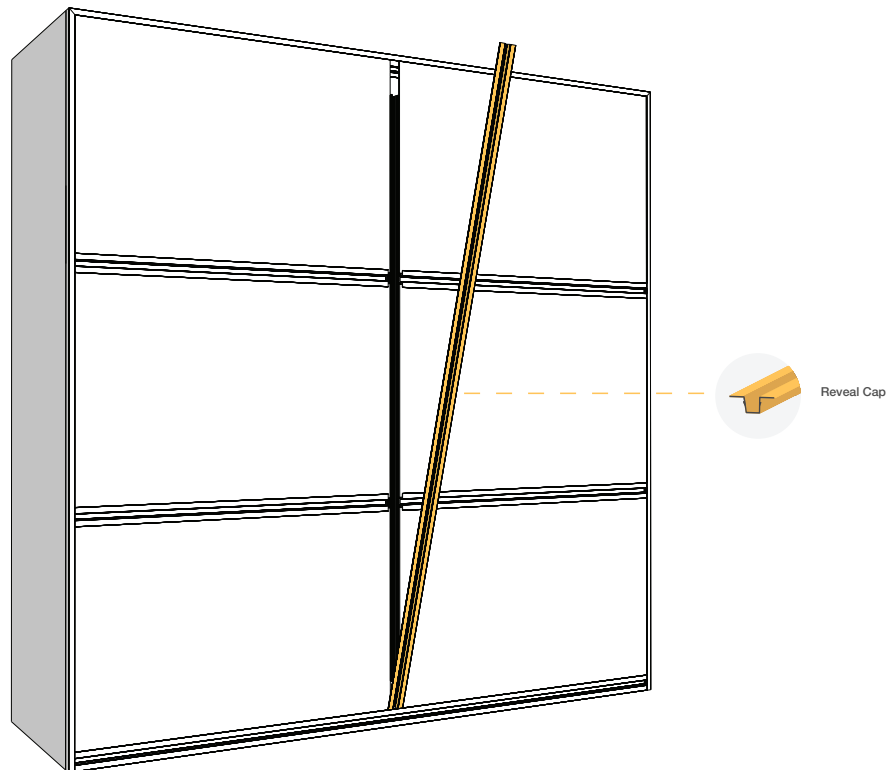

Once two adjacent columns of panels have been installed, the top cap may be installed. Once the top cap is cut to the appropriate length it should be placed, bottom end first, into place, with each end under the tabs of the horizontal End Frames. Once in the correct position it is to be hammered into place with a rubber mallet and AL13® SLED.

If one length of the top cap extrusion is not long enough to span the distance required, it is necessary to use a second piece and butt the two together. Take care in aligning butt-joints so that they share the same back plate. Do not butt two top caps at an intersection, where no back plate is present.

02

Panel Install 18

Wall installation is complete

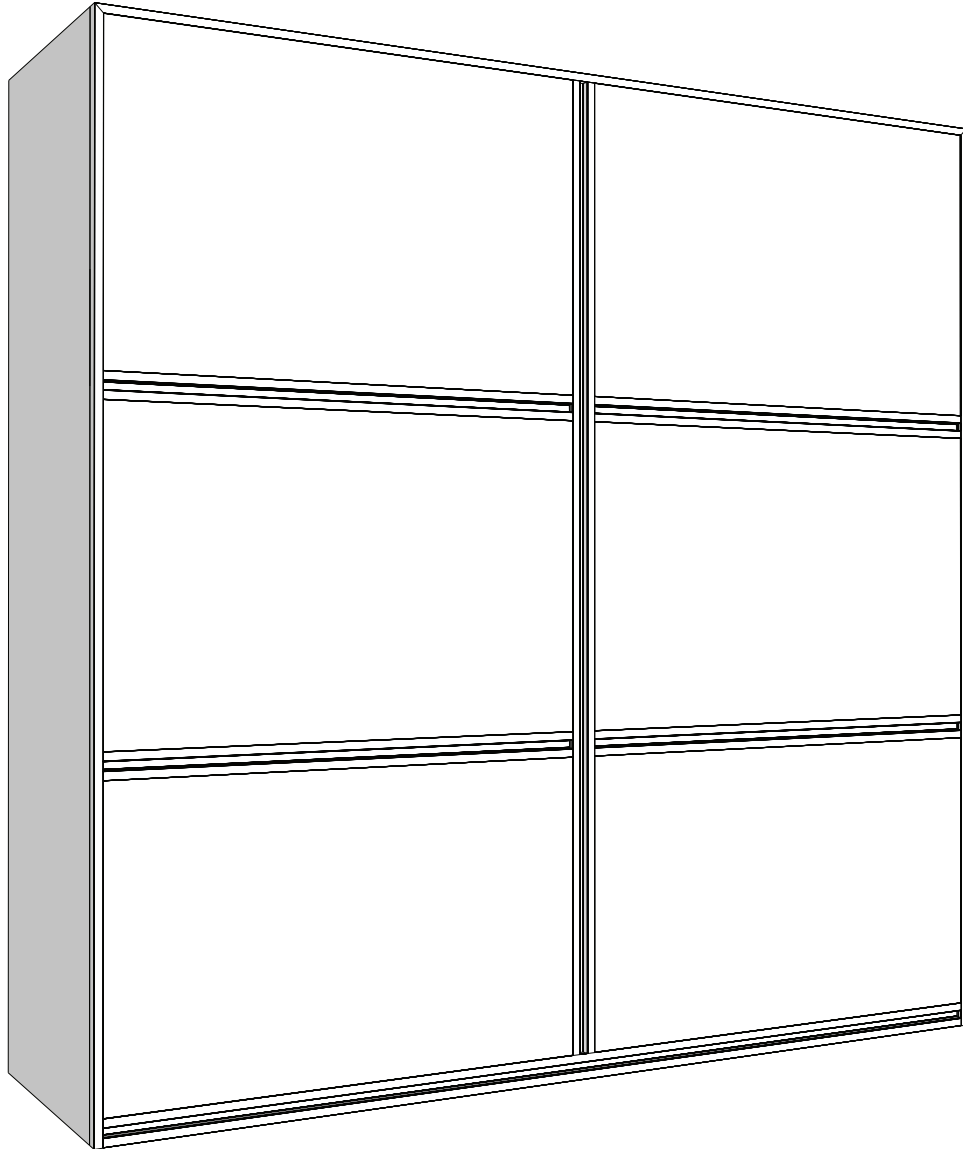

02

Panel Install 19

Finishing and inspection



Once the install is complete, work from the top down to remove the protective plastic film and clean the panels as required. Take note of any installation flaws and ensure all top caps are fully hammered into place.

Protective film must be removed once install is complete.

02

Panel Install 20

Further situations

This General Install guide is intended to show the best practices for a basic install and how the various components work together. It is outside the scope of this manual and impossible to anticipate & outline every installation situation that may be encountered. In order to present the install in the most clear and direct manner, there are a few standard situations that are not covered in this guide. These situations are shown in detail in the following Drawings section, however the below guide will describe how they would install relative to this guide.

Component



End Frame

Generally installed in a vertical or horizontal orientation and is used to terminate the wall system or butt/transition to another wall surface. May be used to butt up to the frames of windows, doors or any other protrusions and recesses in the wall surface.



Inside Corner

Generally installed in a vertical orientation and is used to transition the wall system across a 90° inside corner. May be installed in the same sequence and manner as the Vertical End Frame.



Outside Corner

Generally installed in a vertical orientation and is used to transition the wall system across a 90° outside corner. May be installed in the same sequence and manner as the Vertical End Frame.



Flat Cap

This extrusion is installed both horizontally and vertically. It is generally installed between adjacent panels to connect them. Mates with Half or Full Backplate.



Perimeter Flat Cap

Generally installed horizontally or vertically to terminate the panel system on the wall. It is to be used at the bottom-of-wall panel termination if it is visible from the underside. It can also be used as an alternate to the End Frame or Inside Corner and Outside Corner Frame extrusions. Mates with Half or Full Backplate.



Reveal Cap

This extrusion is installed both horizontally and vertically. It is generally installed between adjacent panels to connect them. Mates with Half or Full Backplate.



Perimeter Reveal Cap

Generally installed horizontally or vertically to terminate the panel system on the wall. It is to be used at the bottom-of-wall panel termination if it is visible from the underside. It can also be used as an alternate to the End Frame or Inside Corner and Outside Corner Frame extrusions. Mates with Half or Full Backplate.

02

Panel Install 21

Component



Half Back Plate

Generally installed in a vertical or horizontal orientation and is used to terminate the panel system on the wall. Mates with Cap profiles.



Full Back Plate

Generally installed in a vertical or horizontal orientation and is used to terminate the panel system on the wall. Mates with Cap profiles.



I-Beam

I-beams may be used in conjunction with the ACM panels to provide additional panel rigidity.



4mm Panel System Clip

Systems clips act as spacers and are installed every 16" - keeping the panels tight to the frame and away from the wall without the need for adjustment.



3mm Panel System Clip

Systems clips act as spacers and are installed every 16" - keeping the panels tight to the frame and away from the wall without the need for adjustment.

In general, the vertical extrusions carry through and the horizontal extrusions are segmented and tuck under the tab of the verticals. Please consult AL13® should there be any questions regarding specialized configurations that are not covered in this installation guide or in the drawing section.

03

Fastener Specifications

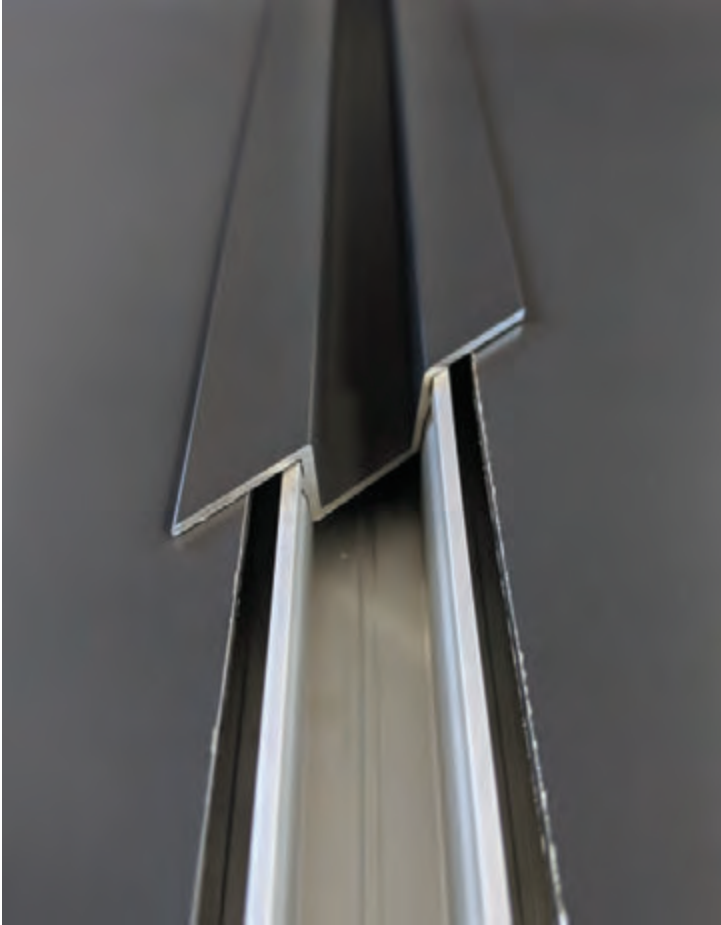

AL13® general installation specifications

For sheathed wood frame, AL13® installs directly on building wrap. The mechanical fasteners anchor into building sheathing and studs where available.

AL13® panels

Panels are fastened by the frame tabs around the entire perimeter. No traditional mechanical fasteners are required in the panel itself.

03

Fastener Specifications

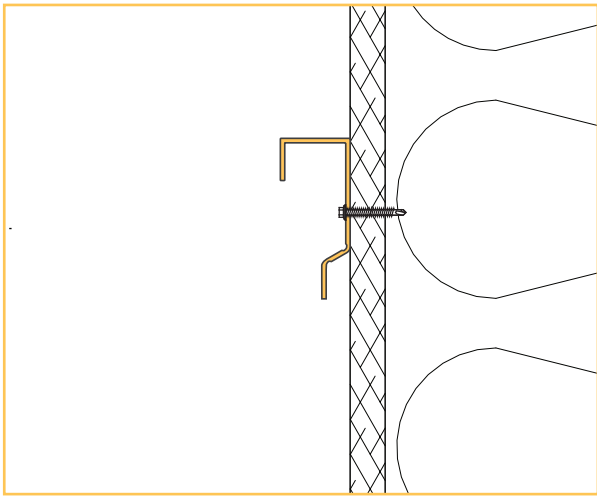

Typical Fastener Install in sheathing - End Frame

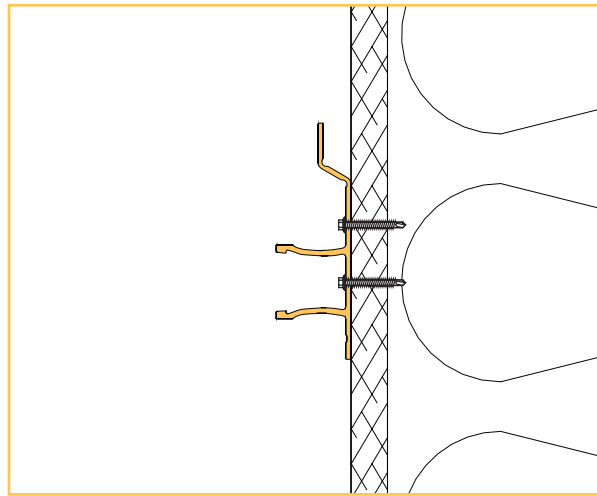

Typical Fastener Install in sheathing - Half Backplate



AL13® Product Warranty

® - 15 YEAR LIMITED PRODUCT WARRANTY, when properly installed and maintained according to the published application. Product is warranted for a period of fifteen (15) years from the date of installation from physical defects. Registration of the product is required for the warranty to be in effect. This warranty is valid for the original customer. This warranty provides the following coverage: (a) delamination, splitting or cracking of the product, sustained excessive deformation of the product under normal conditions of use and (b) to be free of any buckling of the product itself that is not associated with the substrate and/or structure to which the AL13® system is attached. For the purpose of this warranty, buckling shall be defined as warping of the product(s) exceeding one eighth of an inch out of plane per linear foot. If AL13®, after inspection and verification, determines that the product failed under the terms of this limited warranty, the sole and exclusive remedy follows: within a reasonable amount of time after the inspection, repair or replace (at AL13®'s discretion) the defective portion of the product, or may refund the owner for the product(s) affected area, and a reasonable amount of installation. During the warranty period following installation, AL13® will compensate the customer for correcting the affected area(s) (limited to no more than the original cost of installation) until the end of the limited warranty period for the affected area(s).

Finish Warranty

® - 20 YEAR LIMITED FINISH WARRANTY. AL13® hereby warrants that all finishes on the coated aluminum for twenty (20) years from the date of purchase will not under normal atmospheric conditions: (a) peel, check or crack except for such slight crazing or cracking as may occur on certain areas of the panel; or (b) (1) chalk in excess of a numerical rating of 8 measured in accordance with standard procedures as outlined by the "Standard Methods of Evaluating Degree of Chalking of Exterior Paint" - ASTM D4214-89; or (2) fade or change in color in excess of 5 color difference units, as measured by ASTM D2244-89 measured on the exposed painted surfaces which have been cleaned of external deposits and chalk and the corresponding values measured on the original or unexposed painted surfaces. The foregoing being subject to the understanding that fading or color changes may not be uniform if the surface is not evenly exposed to the sun and elements; and that gloss (60° incident angle) loss will not exceed 40% when measured on exposed painted surfaces which have been cleaned of external deposits and the corresponding values measured on unexposed original painted surfaces. The gloss shall be measured using standard procedures as defined by "Standard Test Method for Specular Gloss" - ASTM D523-89.

Finish Warranty Conditions

AL13® finish warranty is subject to the following conditions. (a) The warranty only applies under normal atmospheric conditions and excludes corrosive or aggressive atmospheres such as those contaminated with chemical fumes, salt or other corrosive elements, including areas within 305 meters (1000 feet) of a body of salt water. AL13® recommends a fresh water cleaning/maintenance program in effect to prevent corrosion from accumulated deposits. (b) The warranty will not apply to any coated surface, which is not on the exterior surface of a building. (c) The warranty will not extend or cover: (1) damage to the coating occasioned by moisture or other contamination detrimental to the coating because of improper storage of the coated metal prior to installation; (2) water damage due to condensation caused by improper packaging of the coated metal prior to installation; (3) damages to the coated metal caused by handling, shipping, processing and/or installation; (4) damages to the coated metal caused by scratching or abrading after installation; or (5) damages to the coated metal as a result of standing water in horizontal installations. (d) The warranty will not be applicable to corrosion or failure, which is caused by acts of God, falling objects, external forces, explosions, fire, riots, civil commotions, acts of war, or other such similar or dissimilar occurrences beyond AL13®'s control. Customer shall maintain adequate records to establish identification of the coated material and dates of the installation of the coated metal. (f) Customer shall demonstrate that the failure of the coated metal was due to a breach of the warranty stated herein. (g) AL13®'s exclusive liability under this warranty, or otherwise, will be limited to refinishing, repairing or replacing - at AL13®'s sole option - the defective coated metal. The warranty on any refinished, repaired or replaced coated metal supplied hereunder shall be for the remainder of the warranty period applicable to the originally coated metal. All warranty work will be performed by a company or contractor selected by AL13®, including the initial inspection to verify the claim. Color variance between replacement or repainted product and original product will not be indicative of a defect.

Disclaimer of Implied Warranties & Limitation of Remedies

LIMITED WARRANTIES STATE THE ENTIRE LIABILITY OF AL13® WITH RESPECT TO THE PRODUCTS COVERED BY THEM. AL13® SHALL HAVE NO LIABILITY FOR ANY INDIRECT, SPECIAL, INCIDENTAL OR CONSEQUENTIAL DAMAGES EVEN IF AL13® WAS ADVISED OF THE POSSIBILITY OF SUCH DAMAGES. NO PERSON IS AUTHORIZED TO MAKE ANY REPRESENTATION OR WARRANTY ON BEHALF OF AL13® EXCEPT AS EXPRESSLY SET FORTH ABOVE, AND ANY SUCH STATEMENT SHALL NOT BE BINDING ON AL13®. EXCEPT AS EXPRESSLY SET FORTH ABOVE, AL13® MAKES NO WARRANTY, REPRESENTATION OR CONDITION OF ANY KIND, EXPRESS, IMPLIED, STATUTORY OR OTHERWISE, INCLUDING, WITHOUT LIMITATION, ANY IMPLIED WARRANTY OF MERCHANTABILITY OR FITNESS FOR PARTICULAR PURPOSE. WARRANTIES SHALL BE THE DURATION OF THE LIMITED WARRANTY OR SUCH SHORTER DURATION AS PROVIDED UNDER APPLICABLE LOCAL LAW. THESE LIMITED WARRANTIES GIVE SPECIFIC LEGAL RIGHTS, AND CUSTOMER MAY ALSO HAVE OTHER RIGHTS WHICH VARY FROM AREA TO AREA. Limited warranties will be governed by and construed in accordance with the laws of the Province of British Columbia and the laws of Canada applicable therein, excluding the United Nations Convention on Contracts for the International Sale of Goods. Any claims, demands or causes of action for defects or representations of any nature or damages arising from such defects or representations will be subject to the exclusive jurisdiction of courts located in the Province of British Columbia. CUSTOMER ACKNOWLEDGES AND AGREES TO THE FULLEST EXTENT PERMITTED BY LAW THAT AL13®'S AGGREGATE LIABILITY TO CUSTOMER FOR ANY CLAIMS, LOSSES, COSTS, DAMAGES OR REPAIR EXPENSES FROM ANY CAUSE(S) (INCLUDING LEGAL FEES AND COSTS AND EXPERT WITNESS FEES AND COSTS), SHALL NOT EXCEED THE CONTRACT PRICE PAID BY CUSTOMER. THIS LIMITATION APPLIES TO ANY LIABILITY OR CAUSE OF ACTION, WHETHER BASED ON CONTRACT, TORT (INCLUDING THEORIES OF NEGLIGENCE, RECKLESSNESS, STRICT LIABILITY, OR DEFECTIVE PRODUCT LIABILITY) OR ANY OTHER LEGAL THEORY. THIS DISCLAIMER AND EXCLUSION SHALL APPLY EVEN IF THE EXPRESS WARRANTY SET FORTH ABOVE FAILS OF ITS ESSENTIAL PURPOSE. CUSTOMER ACKNOWLEDGES AND AGREES THAT AL13® HAS SET ITS PRICES IN RELIANCE UPON THE DISCLAIMERS OF WARRANTY AND THE LIMITATIONS OF LIABILITY SET FORTH HEREIN, INCLUDING AN ALLOCATION OF RISK BETWEEN THE PARTIES (INCLUDING THE RISK THAT A REMEDY MAY FAIL OF ITS ESSENTIAL PURPOSE AND CAUSE CONSEQUENTIAL LOSS), AND THAT THE CONTRACT PRICE FORMS AN ESSENTIAL BASIS OF THE BARGAIN BETWEEN AL13® AND CUSTOMER.

Limitations

THE LIMITED WARRANTIES ARE SUBJECT TO THE FOLLOWING GENERAL PROVISIONS AND LIMITATIONS. The limited warranties are effective only if there is proper storage, handling, installation and maintenance of the product in strict accordance with the instructions. Claims must be made in writing to AL13® within 30 days of the discovery of a problem and authorization obtained prior to beginning any repair or replacement work. The claimant must provide proof that he / she is a covered person. Claims can be made by writing to AL13® at the Product Performance Department. After receiving such notice, AL13® must be given an opportunity to inspect and verify the claim. AL13® shall have no liability for defects or damage resulting from (a) misuse or abuse, (b) improper installation, including, but not limited to, inadequate protection against all external damage, (c) performance of coating other than those covered by the limited warranties, (d) contact with harmful chemicals, fumes, or vapors, (e) environmental settlement, shrinkage or distortion of the structure, or (f) fire, wind, flood, lightning, acts of God or other causes beyond the control of AL13®. AL13® shall have no liability for the cost of removing affected products.

Project Details

Owner Full Name:

Install completed on:

Owner Phone Number:

Installer:

Owner Contact Email:

Architect:

Project Name:

General Contractor:

Address:

Supplier:

Submitted on: 2021-3-17 1:34pm

City:

Submitted by:

State/Country: